

# DATA SHEET

**PRODUCT** Metal Oxide Varistor

**SERIES** JVZ Series

**PART NO.**

**QUICK REFERENCE DATA**

PARAMETER	VALUE	UNIT
Size	Ø5~Ø25	mm
Varistor Voltage V1mA	18~1100 V	Volt
Max. Clamping Voltage	40~1815 V	Volt
Withstanding Surge Current ( 8/20µs )	100~20000 A	Amp
Energy (10/1000µs)	0.6~720 J	Joule

**ISSUE DATE** 2022/09/12

**REVISION DATE** 2022/09/12

**REFERENCE NO.**

**RoHS COMPLIANCE ITEM**

**Halogen Free**

**Disclaimer:**

- This datasheet is downloaded from the Website of Joyin Co., Ltd, and Joyin Co., Ltd. reserves all rights for modification content without further notification.
- All product, specification and data are subject to change without notice.
- Joyin Co., Ltd, its affiliates, agents, employees, and all persons acting on its or their behalf, hereby disclaim any and all liability for any errors, inaccuracies or incompleteness contained in any product related information, including but not limited to product specifications, datasheets, pictures and/or graphics.
- Joyin Co., Ltd makes no warranty, representation or guarantee regarding the suitability of the products for any particular purpose or the continuing production of any product. It is the customer's responsibility to validate that a particular product is suitable for use in a particular application.
- To the maximum extent permitted by applicable law, Joyin Co., Ltd disclaims (i) any and all liability arising out of the application or use of any product, (ii) any and all liability, including without limitation special, consequential or incidental damages, and (iii) any and all implied warranties, including warranties of fitness for particular purpose, non-infringement and merchantability.
- If you have any questions, please contact our sales staff.

## Metal Oxide Varistor JVZ Series



### Features

1. RoHS / Halogen-Free (HF) compliant
2. Body size:  $\Phi 5 \sim \Phi 25\text{mm}$
3. Wide operating voltage range: 11Vac ~ 680 Vac
4. Operating temperature range:  $-40^{\circ}\text{C} \sim +105^{\circ}\text{C}$
5. Storage temperature range:  $-40^{\circ}\text{C} \sim +125^{\circ}\text{C}$
6. Agency recognition: UL 1449 4 th / CUL / VDE/ CQC

### Applications

1. Power supply
2. Home appliance
3. Industrial equipment
4. Telecommunication or telephone system
5. Smart meter
6. PLC (Power line communication)
7. Lighting products
8. Photovoltaic industry

### How to order

Part Number Code														
1	2	3	4	5	6	7	8	9	10	11	12	13	14	15
J	V	Z	1	0	S	1	8	1	K	6	5	Y	A	W
①			②		③	④			⑤	⑥	⑦	⑧	⑨	

①	Product Type	JVZ series	④	Varistor Voltage V1mA / V0.1mA for 5mm	180=18V 181=180V 182=1800V	⑦	Lead Spacing	5 = 5mm 7 = 7.5mm 1 = 10mm
②	Body Size	05 = 5mm 07 = 7mm 10 = 10mm 14 = 14mm 20 = 20mm 25 = 25mm	⑤	Tolerance	K=±10% L = ±15% M = ±20% N = ±25%	⑧	Lead Style	P = Straight Lead Y = Vertical Kink Lead *Special lead styles per request
③	Series	N = Standard S = High Surge U = Ultra Surge	⑥	Lead Diameter	6 = 0.6mm 8 = 0.8mm 1 = 1.0mm	⑨	Packaging	50 = 5± 1.0mm for Straight lead 5± 0.5mm for Kink lead U4 = 24mm min. for Bulk and Kink lead U5 = 25mm min. for Bulk and Straight lead AW = H0 16mm for Ammo and Kink lead AY = H0 20mm for Ammo and Straight lead RW = H0 16mm for T / R and Kink lead RY = H0 20mm for T / R and Straight lead

## Metal Oxide Varistor JVZ Series

										*Special spec per request.
--	--	--	--	--	--	--	--	--	--	----------------------------

### Standard Series Specification

#### Agency Approvals

Agency	UL	cUL	VDE		CQC	
Agency Approvals	UL1449 4 <sup>th</sup> Edition	CSA 22.2 No. 269.5-17	IEC61051-1 IEC61051-2 IEC61051-2-2	IEC61051-1 IEC61051-2 IEC61051-2-2 IEC62368-1:2018/G.8.1	GB/T10193-1997 GB/T10194-1997	GB4943.1-2011 GB/T10193-1997 GB/T10194-1997 GB8898-2011
Title	Transient Voltage Surge Suppressors	Transient Voltage Surge Suppressors	Varistors for use in electronic equipment		Engaged in Voluntary Product Certification	
File No.	VZCA2.E325508	VZCA8.E325508	5937		CQC19001230701/702/703/704/705/706	
Symbols	☆				<input type="checkbox"/>	<input checked="" type="checkbox"/>

Ø 5mm

#### Rating and Characteristics

Part No.	Varistor Voltage at 0.1mA		Maximum Allowable Voltage		Maximum Clamping Voltage		Withstanding Surge Current (8/20us)	Nominal Discharge Current (8/20us)	Rated Wattage	Energy (10/1000us)	Certification
	DC (V)	Tolerance	AC rms (V)	DC (V)	V@ic (V)	ic (A)	1 Time (A)	In (KA)	(W)	(J)	
JVZ 05N 180M	18	±20%	11	14	40	1	100	0.1	0.01	0.6	☆ ○ □
JVZ 05N 220L	22	±15%	14	18	48	1	100	0.1	0.01	0.7	☆ ○ □
JVZ 05N 270K	27	±10%	17	22	60	1	100	0.1	0.01	0.9	☆ ○ □
JVZ 05N 330K	33	±10%	20	26	73	1	100	0.1	0.01	1.1	☆ ○ □
JVZ 05N 390K	39	±10%	25	31	86	1	100	0.1	0.01	1.2	☆ ○ □
JVZ 05N 470K	47	±10%	30	38	104	1	100	0.1	0.01	1.5	☆ ○ □
JVZ 05N 560K	56	±10%	35	45	123	1	100	0.1	0.01	1.8	☆ ○ □
JVZ 05N 680K	68	±10%	40	56	150	1	100	0.1	0.01	2.1	☆ ○ □
JVZ 05N 820K	82	±10%	50	65	145	5	400	0.1	0.1	2.8	☆ ○ □
JVZ 05N 101K	100	±10%	60	85	175	5	400	0.1	0.1	3.5	☆ ○ □
JVZ 05N 121K	120	±10%	75	100	210	5	400	0.1	0.1	4	☆ ○ □
JVZ 05N 151K	150	±10%	95	125	260	5	400	0.1	0.1	5.5	☆ ○ □
JVZ 05N 181K	180	±10%	115	150	320	5	400	0.1	0.1	6.5	☆ ○ □
JVZ 05N 201K	200	±10%	130	170	355	5	400	0.1	0.1	7.1	☆ ○ □
JVZ 05N 221K	220	±10%	140	180	380	5	400	0.1	0.1	7.8	☆ ○ □
JVZ 05N 241K	240	±10%	150	200	415	5	400	0.1	0.1	8.4	☆ ○ □
JVZ 05N 271K	270	±10%	175	225	475	5	400	0.1	0.1	9.9	☆ ○ □
JVZ 05N 301K	300	±10%	195	250	525	5	400	0.1	0.1	10.5	☆ ○ □
JVZ 05N 331K	330	±10%	210	275	575	5	400	0.1	0.1	11.5	☆ ○ □
JVZ 05N 361K	360	±10%	230	300	620	5	400	0.1	0.1	13	☆ ○ □
JVZ 05N 391K	390	±10%	250	320	675	5	400	0.1	0.1	15	☆ ○ □
JVZ 05N 431K	430	±10%	275	350	745	5	400	0.1	0.1	16.5	☆ ○ □

## Metal Oxide Varistor JVZ Series

JVZ 05N 471K	470	±10%	300	385	810	5	400	0.1	0.1	17.5	☆ ○ □
JVZ 05N 511K	510	±10%	320	418	880	5	400	0.1	0.1	18.5	☆ ○ □
JVZ 05N 561K	560	±10%	350	460	940	5	400	0.1	0.1	19.5	☆ ○ □
JVZ 05N 621K	620	±10%	385	505	1050	5	400	0.1	0.1	20.5	☆ ○ □
JVZ 05N 681K	680	±10%	420	560	1150	5	400	0.1	0.1	21.5	☆ ○ □
JVZ 05N 751K	750	±10%	460	615	1290	5	400	0.1	0.1	22.5	☆ ○ □

Ø 7mm

### Rating and Characteristics

Part No.	Varistor Voltage at 1mA		Maximum Allowable Voltage		Maximum Clamping Voltage		Withstanding Surge Current (8/20us)	Nominal Discharge Current (8/20us)	Rated Wattage	Energy (10/1000us)	Certification
	DC (V)	Tolerance	AC rms (V)	DC (V)	V@ ic (V)	ic (A)	1 Time (A)	In (KA)	(W)	(J)	
JVZ 07N 180M	18	±20%	11	14	40	2.5	250	0.15	0.02	1.2	☆ ○ □
JVZ 07N 220L	22	±15%	14	18	48	2.5	250	0.15	0.02	1.4	☆ ○ □
JVZ 07N 270K	27	±10%	17	22	60	2.5	250	0.15	0.02	1.7	☆ ○ □
JVZ 07N 330K	33	±10%	20	26	73	2.5	250	0.15	0.02	2.2	☆ ○ □
JVZ 07N 390K	39	±10%	25	31	86	2.5	250	0.15	0.02	2.4	☆ ○ □
JVZ 07N 470K	47	±10%	30	38	104	2.5	250	0.15	0.02	3.0	☆ ○ □
JVZ 07N 560K	56	±10%	35	45	123	2.5	250	0.15	0.02	3.5	☆ ○ □
JVZ 07N 680K	68	±10%	40	56	150	2.5	250	0.15	0.02	4.3	☆ ○ □
JVZ 07N 820K	82	±10%	50	65	145	10	1200	0.5	0.25	5.5	☆ ○ □
JVZ 07N 101K	100	±10%	60	85	175	10	1200	0.5	0.25	7.0	☆ ○ □
JVZ 07N 121K	120	±10%	75	100	210	10	1200	0.5	0.25	8.0	☆ ○ □
JVZ 07N 151K	150	±10%	95	125	260	10	1200	0.5	0.25	11.0	☆ ○ □
JVZ 07N 181K	180	±10%	115	150	320	10	1200	0.5	0.25	13.0	☆ ○ □
JVZ 07N 201K	200	±10%	130	170	355	10	1200	0.5	0.25	14.3	☆ ○ □
JVZ 07N 221K	220	±10%	140	180	380	10	1200	0.5	0.25	15.5	☆ ○ □
JVZ 07N 241K	240	±10%	150	200	415	10	1200	0.5	0.25	16.8	☆ ○ □
JVZ 07N 271K	270	±10%	175	225	475	10	1200	0.5	0.25	19.8	☆ ○ □
JVZ 07N 301K	300	±10%	195	250	525	10	1200	0.5	0.25	21.0	☆ ○ □
JVZ 07N 331K	330	±10%	210	275	575	10	1200	0.5	0.25	23.0	☆ ○ □
JVZ 07N 361K	360	±10%	230	300	620	10	1200	0.5	0.25	26.0	☆ ○ □
JVZ 07N 391K	390	±10%	250	320	675	10	1200	0.5	0.25	30.0	☆ ○ □
JVZ 07N 431K	430	±10%	275	350	745	10	1200	0.5	0.25	33.0	☆ ○ □
JVZ 07N 471K	470	±10%	300	385	810	10	1200	0.5	0.25	35.0	☆ ○ □
JVZ 07N 511K	510	±10%	320	418	880	10	1200	0.5	0.25	37.0	☆ ○ □
JVZ 07N 561K	560	±10%	350	460	940	10	1200	0.5	0.25	39.0	☆ ○ □
JVZ 07N 621K	620	±10%	385	505	1050	10	1200	0.5	0.25	41.0	☆ ○ □
JVZ 07N 681K	680	±10%	420	560	1150	10	1200	0.5	0.25	43.0	☆ ○ □
JVZ 07N 751K	750	±10%	460	615	1290	10	1200	0.5	0.25	45.0	☆ ○ □
JVZ 07N 781K	780	±10%	485	640	1290	10	1200	0.5	0.25	46.0	☆ ○ □
JVZ 07N 821K	820	±10%	510	670	1355	10	1200	0.5	0.25	47.0	☆ ○ □

## Metal Oxide Varistor JVZ Series

Ø 10mm

### Rating and Characteristics

Part No.	Varistor Voltage at 1mA		Maximum Allowable Voltage		Maximum Clamping Voltage		Withstanding Surge Current (8/20us)	Nominal Discharge Current (8/20us)	Rated Wattage	Energy (10/1000us)	Certification
	DC (V)	Tolerance	AC rms (V)	DC (V)	V@ ic (V)	ic (A)	1 Time (A)	In (KA)	(W)	(J)	
JVZ 10N 180M	18	±20%	11	14	36	5	500	0.25	0.05	2.4	☆ ○ □
JVZ 10N 220L	22	±15%	14	18	43	5	500	0.25	0.05	2.7	☆ ○ □
JVZ 10N 270K	27	±10%	17	22	53	5	500	0.25	0.05	3.5	☆ ○ □
JVZ 10N 330K	33	±10%	20	26	65	5	500	0.25	0.05	4.4	☆ ○ □
JVZ 10N 390K	39	±10%	25	31	77	5	500	0.25	0.05	4.7	☆ ○ □
JVZ 10N 470K	47	±10%	30	38	93	5	500	0.25	0.05	6.0	☆ ○ □
JVZ 10N 560K	56	±10%	35	45	110	5	500	0.25	0.05	7.0	☆ ○ □
JVZ 10N 680K	68	±10%	40	56	135	5	500	0.25	0.05	8.5	☆ ○ □
JVZ 10N 820K	82	±10%	50	65	135	25	2500	1.5	0.4	11.0	☆ ○ □
JVZ 10N 101K	100	±10%	60	85	165	25	2500	1.5	0.4	14.0	☆ ○ □
JVZ 10N 121K	120	±10%	75	100	200	25	2500	1.5	0.4	16.0	☆ ○ □
JVZ 10N 151K	150	±10%	95	125	250	25	2500	1.5	0.4	22.0	☆ ○ □
JVZ 10N 181K	180	±10%	115	150	300	25	2500	1.5	0.4	26.0	☆ ● □
JVZ 10N 201K	200	±10%	130	170	340	25	2500	1.5	0.4	28.5	☆ ● ■
JVZ 10N 221K	220	±10%	140	180	360	25	2500	1.5	0.4	31.0	☆ ● ■
JVZ 10N 241K	240	±10%	150	200	395	25	2500	1.5	0.4	33.5	☆ ● ■
JVZ 10N 271K	270	±10%	175	225	455	25	2500	1.5	0.4	39.5	☆ ● ■
JVZ 10N 301K	300	±10%	195	250	505	25	2500	1.5	0.4	42.0	☆ ● ■
JVZ 10N 331K	330	±10%	210	275	550	25	2500	1.5	0.4	46.0	☆ ● ■
JVZ 10N 361K	360	±10%	230	300	595	25	2500	1.5	0.4	52.0	☆ ● ■
JVZ 10N 391K	390	±10%	250	320	650	25	2500	1.5	0.4	60.0	☆ ● ■
JVZ 10N 431K	430	±10%	275	350	710	25	2500	1.5	0.4	66.0	☆ ● ■
JVZ 10N 471K	470	±10%	300	385	775	25	2500	1.5	0.4	70.0	☆ ● ■
JVZ 10N 511K	510	±10%	320	418	842	25	2500	1.5	0.4	74.0	☆ ● ■
JVZ 10N 561K	560	±10%	350	460	920	25	2500	1.5	0.4	78.0	☆ ● ■
JVZ 10N 621K	620	±10%	385	505	1025	25	2500	1.5	0.4	82.0	☆ ● ■
JVZ 10N 681K	680	±10%	420	560	1120	25	2500	1.5	0.4	86.0	☆ ● ■
JVZ 10N 751K	750	±10%	460	615	1240	25	2500	1.5	0.4	90.0	☆ ● ■
JVZ 10N 781K	780	±10%	485	640	1290	25	2500	1.5	0.4	92.0	☆ ● ■
JVZ 10N 821K	820	±10%	510	670	1355	25	2500	1.5	0.4	94.0	☆ ● ■
JVZ 10N 911K	910	±10%	550	745	1500	25	2500	1.5	0.4	102.0	☆ ● ■
JVZ 10N 102K	1000	±10%	625	825	1650	25	2500	1.5	0.4	112.0	☆ ● ■
JVZ 10N 112K	1100	±10%	680	895	1815	25	2500	1.5	0.4	124.0	☆ ● ■

## Metal Oxide Varistor JVZ Series

Ø 14mm

### Rating and Characteristics

Part No.	Varistor Voltage at 1mA		Maximum Allowable Voltage		Maximum Clamping Voltage		Withstanding Surge Current (8/20us)	Nominal Discharge Current (8/20us)	Rated Wattage	Energy (10/1000us)	Certification
	DC (V)	Tolerance	AC rms (V)	DC (V)	V@ ic (V)	ic (A)	1 Time (A)	In (KA)	(W)	(J)	
JVZ 14N 180M	18	±20%	11	14	36	10	1000	1	0.1	4.7	☆ ○ □
JVZ 14N 220L	22	±15%	14	18	43	10	1000	1	0.1	5.4	☆ ○ □
JVZ 14N 270K	27	±10%	17	22	53	10	1000	1	0.1	6.9	☆ ○ □
JVZ 14N 330K	33	±10%	20	26	65	10	1000	1	0.1	8.8	☆ ○ □
JVZ 14N 390K	39	±10%	25	31	77	10	1000	1	0.1	9.4	☆ ○ □
JVZ 14N 470K	47	±10%	30	38	93	10	1000	1	0.1	12	☆ ○ □
JVZ 14N 560K	56	±10%	35	45	110	10	1000	1	0.1	14	☆ ○ □
JVZ 14N 680K	68	±10%	40	56	135	10	1000	1	0.1	17	☆ ○ □
JVZ 14N 820K	82	±10%	50	65	135	50	4500	3	0.6	22	☆ ○ □
JVZ 14N 101K	100	±10%	60	85	165	50	4500	3	0.6	28	☆ ○ □
JVZ 14N 121K	120	±10%	75	100	200	50	4500	3	0.6	32	☆ ○ □
JVZ 14N 151K	150	±10%	95	125	250	50	4500	3	0.6	44	☆ ○ □
JVZ 14N 181K	180	±10%	115	150	300	50	4500	3	0.6	52	☆ ● □
JVZ 14N 201K	200	±10%	130	170	340	50	4500	3	0.6	57	☆ ● ■
JVZ 14N 221K	220	±10%	140	180	360	50	4500	3	0.6	62	☆ ● ■
JVZ 14N 241K	240	±10%	150	200	395	50	4500	3	0.6	67	☆ ● ■
JVZ 14N 271K	270	±10%	175	225	455	50	4500	3	0.6	79	☆ ● ■
JVZ 14N 301K	300	±10%	195	250	505	50	4500	3	0.6	84	☆ ● ■
JVZ 14N 331K	330	±10%	210	275	550	50	4500	3	0.6	92	☆ ● ■
JVZ 14N 361K	360	±10%	230	300	595	50	4500	3	0.6	104	☆ ● ■
JVZ 14N 391K	390	±10%	250	320	650	50	4500	3	0.6	120	☆ ● ■
JVZ 14N 431K	430	±10%	275	350	710	50	4500	3	0.6	132	☆ ● ■
JVZ 14N 471K	470	±10%	300	385	775	50	4500	3	0.6	140	☆ ● ■
JVZ 14N 511K	510	±10%	320	418	842	50	4500	3	0.6	148	☆ ● ■
JVZ 14N 561K	560	±10%	350	460	920	50	4500	3	0.6	156	☆ ● ■
JVZ 14N 621K	620	±10%	385	505	1025	50	4500	3	0.6	164	☆ ● ■
JVZ 14N 681K	680	±10%	420	560	1120	50	4500	3	0.6	172	☆ ● ■
JVZ 14N 751K	750	±10%	460	615	1240	50	4500	3	0.6	180	☆ ● ■
JVZ 14N 781K	780	±10%	485	640	1290	50	4500	3	0.6	184	☆ ● ■
JVZ 14N 821K	820	±10%	510	670	1355	50	4500	3	0.6	188	☆ ● ■
JVZ 14N 911K	910	±10%	550	745	1500	50	4500	3	0.6	204	☆ ● ■
JVZ 14N 102K	1000	±10%	625	825	1650	50	4500	3	0.6	224	☆ ● ■
JVZ 14N 112K	1100	±10%	680	895	1815	50	4500	3	0.6	248	☆ ● ■

## Metal Oxide Varistor JVZ Series

Ø 20mm

### Rating and Characteristics

Part No.	Varistor Voltage at 1mA		Maximum Allowable Voltage		Maximum Clamping Voltage		Withstanding Surge Current (8/20us)	Nominal Discharge Current (8/20us)	Rated Wattage	Energy (10/1000us)	Certification
	DC (V)	Tolerance	AC rms (V)	DC (V)	V@ ic (V)	ic (A)	1 Time (A)	In (KA)	(W)	(J)	
JVZ 20N 220M	22	±20%	14	18	43	20	2000	2	0.2	8	☆ ○ □
JVZ 20N 270M	27	±20%	17	22	53	20	2000	2	0.2	10	☆ ○ □
JVZ 20N 330M	33	±20%	20	26	65	20	2000	2	0.2	12	☆ ○ □
JVZ 20N 390L	39	±15%	25	31	77	20	2000	2	0.2	14	☆ ○ □
JVZ 20N 470L	47	±15%	30	38	93	20	2000	2	0.2	17	☆ ○ □
JVZ 20N 560L	56	±15%	35	45	110	20	2000	2	0.2	20	☆ ○ □
JVZ 20N 680L	68	±15%	40	56	135	20	2000	2	0.2	24	☆ ○ □
JVZ 20N 820L	82	±15%	50	65	135	100	6500	5	1	44	☆ ○ □
JVZ 20N 101K	100	±10%	60	85	165	100	6500	5	1	56	☆ ○ □
JVZ 20N 121K	120	±10%	75	100	200	100	6500	5	1	64	☆ ○ □
JVZ 20N 151K	150	±10%	95	125	250	100	6500	5	1	88	☆ ○ □
JVZ 20N 181K	180	±10%	115	150	300	100	6500	5	1	104	☆ ● ■
JVZ 20N 201K	200	±10%	130	170	340	100	6500	5	1	114	☆ ● ■
JVZ 20N 221K	220	±10%	140	180	360	100	6500	5	1	124	☆ ● ■
JVZ 20N 241K	240	±10%	150	200	395	100	6500	5	1	134	☆ ● ■
JVZ 20N 271K	270	±10%	175	225	455	100	6500	5	1	158	☆ ● ■
JVZ 20N 301K	300	±10%	195	250	505	100	6500	5	1	168	☆ ● ■
JVZ 20N 331K	330	±10%	210	275	550	100	6500	5	1	184	☆ ● ■
JVZ 20N 361K	360	±10%	230	300	595	100	6500	5	1	208	☆ ● ■
JVZ 20N 391K	390	±10%	250	320	650	100	6500	5	1	240	☆ ● ■
JVZ 20N 431K	430	±10%	275	350	710	100	6500	5	1	264	☆ ● ■
JVZ 20N 471K	470	±10%	300	385	775	100	6500	5	1	280	☆ ● ■
JVZ 20N 511K	510	±10%	320	418	842	100	6500	5	1	296	☆ ● ■
JVZ 20N 561K	560	±10%	350	460	920	100	6500	5	1	312	☆ ● ■
JVZ 20N 621K	620	±10%	385	505	1025	100	6500	5	1	328	☆ ● ■
JVZ 20N 681K	680	±10%	420	560	1120	100	6500	5	1	344	☆ ● ■
JVZ 20N 751K	750	±10%	460	615	1240	100	6500	5	1	360	☆ ● ■
JVZ 20N 781K	780	±10%	485	640	1290	100	6500	5	1	368	☆ ● ■
JVZ 20N 821K	820	±10%	510	670	1355	100	6500	5	1	376	☆ ● ■
JVZ 20N 911K	910	±10%	550	745	1500	100	6500	5	1	408	☆ ● ■
JVZ 20N 102K	1000	±10%	625	825	1650	100	6500	5	1	448	☆ ● ■
JVZ 20N 112K	1100	±10%	680	895	1815	100	6500	5	1	496	☆ ● ■

## Metal Oxide Varistor JVZ Series

Ø 25mm

### Rating and Characteristics

Part No.	Varistor Voltage at 1mA		Maximum Allowable Voltage		Maximum Clamping Voltage		Withstanding Surge Current (8/20us)	Nominal Discharge Current (8/20us)	Rated Wattage	Energy (10/1000us)	Certification
	DC (V)	Tolerance	AC rms (V)	DC (V)	V@ ic (V)	ic (A)	1 Time (A)	In (KA)	(W)	(J)	
JVZ 25N 201K	200	±10%	130	170	355	150	20000	5	1.2	190	☆ ●
JVZ 25N 221K	220	±10%	140	180	380	150	20000	5	1.2	205	☆ ●
JVZ 25N 241K	240	±10%	150	200	415	150	20000	5	1.2	225	☆ ●
JVZ 25N 271K	270	±10%	175	225	445	150	20000	5	1.2	255	☆ ●
JVZ 25N 301K	300	±10%	195	250	495	150	20000	5	1.2	280	☆ ●
JVZ 25N 331K	330	±10%	210	275	545	150	20000	5	1.2	305	☆ ●
JVZ 25N 361K	360	±10%	230	300	595	150	20000	5	1.2	330	☆ ●
JVZ 25N 391K	390	±10%	250	320	645	150	20000	5	1.2	360	☆ ●
JVZ 25N 431K	430	±10%	275	350	710	150	20000	5	1.2	380	☆ ●
JVZ 25N 471K	470	±10%	300	385	775	150	20000	5	1.2	400	☆ ●
JVZ 25N 511K	510	±10%	320	418	840	150	20000	5	1.2	420	☆ ●
JVZ 25N 561K	560	±10%	350	460	925	150	20000	5	1.2	440	☆ ●
JVZ 25N 621K	620	±10%	385	505	1025	150	20000	5	1.2	460	☆ ●
JVZ 25N 681K	680	±10%	420	560	1125	150	20000	5	1.2	480	☆ ●
JVZ 25N 751K	750	±10%	460	615	1240	150	20000	5	1.2	520	☆ ●
JVZ 25N 781K	780	±10%	485	640	1290	150	20000	5	1.2	540	☆ ●
JVZ 25N 821K	820	±10%	510	670	1360	150	20000	5	1.2	570	☆ ●
JVZ 25N 911K	910	±10%	550	745	1500	150	20000	5	1.2	620	☆ ●



# Metal Oxide Varistor JVZ Series

## High Surge Series Specification

### Agency Approvals

Agency	UL	CUL	VDE		CQC	
Agency Approvals	UL1449 4 <sup>th</sup> Edition	CSA 22.2 No. 269.5-17	IEC61051-1 IEC61051-2 IEC61051-2-2	IEC61051-1 IEC61051-2 IEC61051-2-2 IEC62368-1:2018/G.8.1	GB/T10193-1997 GB/T10194-1997	GB4943.1-2011 GB/T10193-1997 GB/T10194-1997 GB8898-2011
Title	Transient Voltage Surge Suppressors	Transient Voltage Surge Suppressors	Varistors for use in electronic equipment		Engaged in Voluntary Product Certification	
File No.	VZCA2.E325508	VZCA8.E325508	40004658		CQC19001230701/703/704/705/706	
Symbols	☆		○	●	□	■

Ø 5mm

### Rating and Characteristics

Part No.	Varistor Voltage at 0.1mA		Maximum Allowable Voltage		Maximum Clamping Voltage		Withstanding Surge Current (8/20us)	Nominal Discharge Current (8/20us)	Rated Wattage	Energy (10/1000us)	Certification
	DC (V)	Tolerance	AC rms (V)	DC (V)	V@ ic (V)	ic (A)	1 Time (A)	In (KA)	(W)	(J)	UL US D'E CQC
JVZ 05S 180M	18	±20%	11	14	40	1	250	0.1	0.01	0.7	☆ ○ □
JVZ 05S 220L	22	±15%	14	18	48	1	250	0.1	0.01	0.8	☆ ○ □
JVZ 05S 270K	27	±10%	17	22	60	1	250	0.1	0.01	1.1	☆ ○ □
JVZ 05S 330K	33	±10%	20	26	73	1	250	0.1	0.01	1.3	☆ ○ □
JVZ 05S 390K	39	±10%	25	31	86	1	250	0.1	0.01	1.5	☆ ○ □
JVZ 05S 470K	47	±10%	30	38	104	1	250	0.1	0.01	1.8	☆ ○ □
JVZ 05S 560K	56	±10%	35	45	123	1	250	0.1	0.01	2.2	☆ ○ □
JVZ 05S 680K	68	±10%	40	56	150	1	250	0.1	0.01	2.6	☆ ○ □
JVZ 05S 820K	82	±10%	50	65	145	5	800	0.1	0.1	3.5	☆ ○ □
JVZ 05S 101K	100	±10%	60	85	175	5	800	0.1	0.1	4.5	☆ ○ □
JVZ 05S 121K	120	±10%	75	100	210	5	800	0.1	0.1	5.5	☆ ○ □
JVZ 05S 151K	150	±10%	95	125	260	5	800	0.1	0.1	6.5	☆ ○ □
JVZ 05S 181K	180	±10%	115	150	320	5	800	0.1	0.1	8.0	☆ ○ □
JVZ 05S 201K	200	±10%	130	170	355	5	800	0.1	0.1	8.5	☆ ○ □
JVZ 05S 221K	220	±10%	140	180	380	5	800	0.1	0.1	9.0	☆ ○ □
JVZ 05S 241K	240	±10%	150	200	415	5	800	0.1	0.1	10.5	☆ ○ □
JVZ 05S 271K	270	±10%	175	225	475	5	800	0.1	0.1	11	☆ ○ □
JVZ 05S 301K	300	±10%	195	250	525	5	800	0.1	0.1	12.0	☆ ○ □
JVZ 05S 331K	330	±10%	210	275	575	5	800	0.1	0.1	13	☆ ○ □
JVZ 05S 361K	360	±10%	230	300	620	5	800	0.1	0.1	16	☆ ○ □
JVZ 05S 391K	390	±10%	250	320	675	5	800	0.1	0.1	17	☆ ○ □
JVZ 05S 431K	430	±10%	275	350	745	5	800	0.1	0.1	20	☆ ○ □
JVZ 05S 471K	470	±10%	300	385	810	5	800	0.1	0.1	21	☆ ○ □
JVZ 05S 511K	510	±10%	320	418	880	5	800	0.1	0.1	22	☆ ○ □
JVZ 05S 561K	560	±10%	350	460	940	5	800	0.1	0.1	25	☆ ○ □
JVZ 05S 621K	620	±10%	385	505	1050	5	800	0.1	0.1	27	☆ ○ □
JVZ 05S 681K	680	±10%	420	560	1150	5	800	0.1	0.1	28	☆ ○ □
JVZ 05S 751K	750	±10%	460	615	1290	5	800	0.1	0.1	29	☆ ○ □

## Metal Oxide Varistor JVZ Series

Ø 7mm

### Rating and Characteristics

Part No.	Varistor Voltage at 1mA		Maximum Allowable Voltage		Maximum Clamping Voltage		Withstanding Surge Current (8/20us)	Nominal Discharge Current (8/20us)	Rated Wattage	Energy (10/1000us)	Certification
	DC (V)	Tolerance	AC rms (V)	DC (V)	V@ ic (V)	ic (A)	1 Time (A)	In (KA)	(W)	(J)	
JVZ 07S 180M	18	±20%	11	14	40	2.5	500	0.25	0.02	1.5	☆ ○ □
JVZ 07S 220L	22	±15%	14	18	48	2.5	500	0.25	0.02	1.7	☆ ○ □
JVZ 07S 270K	27	±10%	17	22	60	2.5	500	0.25	0.02	2.1	☆ ○ □
JVZ 07S 330K	33	±10%	20	26	73	2.5	500	0.25	0.02	2.8	☆ ○ □
JVZ 07S 390K	39	±10%	25	31	86	2.5	500	0.25	0.02	3.0	☆ ○ □
JVZ 07S 470K	47	±10%	30	38	104	2.5	500	0.25	0.02	3.8	☆ ○ □
JVZ 07S 560K	56	±10%	35	45	123	2.5	500	0.25	0.02	4.4	☆ ○ □
JVZ 07S 680K	68	±10%	40	56	150	2.5	500	0.25	0.02	5.4	☆ ○ □
JVZ 07S 820K	82	±10%	50	65	145	10	1750	1.0	0.25	7.0	☆ ○ □
JVZ 07S 101K	100	±10%	60	85	175	10	1750	1.0	0.25	9.0	☆ ○ □
JVZ 07S 121K	120	±10%	75	100	210	10	1750	1.0	0.25	11	☆ ○ □
JVZ 07S 151K	150	±10%	95	125	260	10	1750	1.0	0.25	13	☆ ○ □
JVZ 07S 181K	180	±10%	115	150	320	10	1750	1.0	0.25	16	☆ ○ □
JVZ 07S 201K	200	±10%	130	170	355	10	1750	1.0	0.25	17.5	☆ ○ □
JVZ 07S 221K	220	±10%	140	180	380	10	1750	1.0	0.25	19	☆ ○ □
JVZ 07S 241K	240	±10%	150	200	415	10	1750	1.0	0.25	21	☆ ○ □
JVZ 07S 271K	270	±10%	175	225	475	10	1750	1.0	0.25	24	☆ ○ □
JVZ 07S 301K	300	±10%	195	250	525	10	1750	1.0	0.25	26	☆ ○ □
JVZ 07S 331K	330	±10%	210	275	575	10	1750	1.0	0.25	28	☆ ○ □
JVZ 07S 361K	360	±10%	230	300	620	10	1750	1.0	0.25	32	☆ ○ □
JVZ 07S 391K	390	±10%	250	320	675	10	1750	1.0	0.25	35	☆ ○ □
JVZ 07S 431K	430	±10%	275	350	745	10	1750	1.0	0.25	40	☆ ○ □
JVZ 07S 471K	470	±10%	300	385	810	10	1750	1.0	0.25	42	☆ ○ □
JVZ 07S 511K	510	±10%	320	418	880	10	1750	1.0	0.25	45	☆ ○ □
JVZ 07S 561K	560	±10%	350	460	940	10	1750	1.0	0.25	51	☆ ○ □
JVZ 07S 621K	620	±10%	385	505	1050	10	1750	1.0	0.25	54	☆ ○ □
JVZ 07S 681K	680	±10%	420	560	1150	10	1750	1.0	0.25	56	☆ ○ □
JVZ 07S 751K	750	±10%	460	615	1290	10	1750	1.0	0.25	58	☆ ○ □
JVZ 07S 781K	780	±10%	485	640	1290	10	1750	1.0	0.25	59	☆ ○ □
JVZ 07S 821K	820	±10%	510	670	1355	10	1750	1.0	0.25	60	☆ ○ □

## Metal Oxide Varistor JVZ Series

Ø 10mm

### Rating and Characteristics

Part No.	Varistor Voltage at 1mA		Maximum Allowable Voltage		Maximum Clamping Voltage		Withstanding Surge Current (8/20us)	Nominal Discharge Current (8/20us)	Rated Wattage	Energy (10/1000us)	Certification
	DC (V)	Tolerance	AC rms (V)	DC (V)	V@ ic (V)	ic (A)	1 Time (A)	In (KA)	(W)	(J)	
JVZ 10S 180M	18	±20%	11	14	36	5	1000	0.5	0.05	2.6	☆ ○ □
JVZ 10S 220L	22	±15%	14	18	43	5	1000	0.5	0.05	3.2	☆ ○ □
JVZ 10S 270K	27	±10%	17	22	53	5	1000	0.5	0.05	3.9	☆ ○ □
JVZ 10S 330K	33	±10%	20	26	65	5	1000	0.5	0.05	4.8	☆ ○ □
JVZ 10S 390K	39	±10%	25	31	77	5	1000	0.5	0.05	5.6	☆ ○ □
JVZ 10S 470K	47	±10%	30	38	93	5	1000	0.5	0.05	6.8	☆ ○ □
JVZ 10S 560K	56	±10%	35	45	110	5	1000	0.5	0.05	8.1	☆ ○ □
JVZ 10S 680K	68	±10%	40	56	135	5	1000	0.5	0.05	9.8	☆ ○ □
JVZ 10S 820K	82	±10%	50	65	135	25	3500	1.5	0.4	14	☆ ○ □
JVZ 10S 101K	100	±10%	60	85	165	25	3500	1.5	0.4	18	☆ ○ □
JVZ 10S 121K	120	±10%	75	100	200	25	3500	1.5	0.4	22	☆ ○ □
JVZ 10S 151K	150	±10%	95	125	250	25	3500	1.5	0.4	25	☆ ○ □
JVZ 10S 181K	180	±10%	115	150	300	25	3500	1.5	0.4	32	☆ ● □
JVZ 10S 201K	200	±10%	130	170	340	25	3500	1.5	0.4	35	☆ ● ■
JVZ 10S 221K	220	±10%	140	180	360	25	3500	1.5	0.4	39	☆ ● ■
JVZ 10S 241K	240	±10%	150	200	395	25	3500	1.5	0.4	42	☆ ● ■
JVZ 10S 271K	270	±10%	175	225	455	25	3500	1.5	0.4	49	☆ ● ■
JVZ 10S 301K	300	±10%	195	250	505	25	3500	1.5	0.4	52	☆ ● ■
JVZ 10S 331K	330	±10%	210	275	550	25	3500	1.5	0.4	58	☆ ● ■
JVZ 10S 361K	360	±10%	230	300	595	25	3500	1.5	0.4	65	☆ ● ■
JVZ 10S 391K	390	±10%	250	320	650	25	3500	1.5	0.4	70	☆ ● ■
JVZ 10S 431K	430	±10%	275	350	710	25	3500	1.5	0.4	80	☆ ● ■
JVZ 10S 471K	470	±10%	300	385	775	25	3500	1.5	0.4	85	☆ ● ■
JVZ 10S 511K	510	±10%	320	418	842	25	3500	1.5	0.4	92	☆ ● ■
JVZ 10S 561K	560	±10%	350	460	920	25	3500	1.5	0.4	102	☆ ● ■
JVZ 10S 621K	620	±10%	385	505	1025	25	3500	1.5	0.4	107	☆ ● ■
JVZ 10S 681K	680	±10%	420	560	1120	25	3500	1.5	0.4	112	☆ ● ■
JVZ 10S 751K	750	±10%	460	615	1240	25	3500	1.5	0.4	115	☆ ● ■
JVZ 10S 781K	780	±10%	485	640	1290	25	3500	1.5	0.4	116	☆ ● ■
JVZ 10S 821K	820	±10%	510	670	1355	25	3500	1.5	0.4	118	☆ ● ■
JVZ 10S 911K	910	±10%	550	745	1500	25	3500	1.5	0.4	127	☆ ● ■
JVZ 10S 102K	1000	±10%	625	825	1650	25	3500	1.5	0.4	140	☆ ● ■
JVZ 10S 112K	1100	±10%	680	895	1815	25	3500	1.5	0.4	155	☆ ● ■

## Metal Oxide Varistor JVZ Series

Ø 14mm

### Rating and Characteristics

Part No.	Varistor Voltage at 1mA		Maximum Allowable Voltage		Maximum Clamping Voltage		Withstanding Surge Current (8/20us)	Nominal Discharge Current (8/20us)	Rated Wattage	Energy (10/1000us)	Certification
	DC (V)	Tolerance	AC rms (V)	DC (V)	V@ ic (V)	ic (A)	1 Time (A)	In (KA)	(W)	(J)	
JVZ 14S 180M	18	±20%	11	14	36	10	2000	1	0.1	5.2	☆ ○ □
JVZ 14S 220L	22	±15%	14	18	43	10	2000	1	0.1	6.3	☆ ○ □
JVZ 14S 270K	27	±10%	17	22	53	10	2000	1	0.1	7.8	☆ ○ □
JVZ 14S 330K	33	±10%	20	26	65	10	2000	1	0.1	9.5	☆ ○ □
JVZ 14S 390K	39	±10%	25	31	77	10	2000	1	0.1	11	☆ ○ □
JVZ 14S 470K	47	±10%	30	38	93	10	2000	1	0.1	14	☆ ○ □
JVZ 14S 560K	56	±10%	35	45	110	10	2000	1	0.1	16	☆ ○ □
JVZ 14S 680K	68	±10%	40	56	135	10	2000	1	0.1	20	☆ ○ □
JVZ 14S 820K	82	±10%	50	65	135	50	6000	3	0.6	28	☆ ○ □
JVZ 14S 101K	100	±10%	60	85	165	50	6000	3	0.6	36	☆ ○ □
JVZ 14S 121K	120	±10%	75	100	200	50	6000	3	0.6	44	☆ ○ □
JVZ 14S 151K	150	±10%	95	125	250	50	6000	3	0.6	53	☆ ○ □
JVZ 14S 181K	180	±10%	115	150	300	50	6000	3	0.6	65	☆ ● □
JVZ 14S 201K	200	±10%	130	170	340	50	6000	3	0.6	70	☆ ● ■
JVZ 14S 221K	220	±10%	140	180	360	50	6000	3	0.6	78	☆ ● ■
JVZ 14S 241K	240	±10%	150	200	395	50	6000	3	0.6	84	☆ ● ■
JVZ 14S 271K	270	±10%	175	225	455	50	6000	3	0.6	99	☆ ● ■
JVZ 14S 301K	300	±10%	195	250	505	50	6000	3	0.6	105	☆ ● ■
JVZ 14S 331K	330	±10%	210	275	550	50	6000	3	0.6	115	☆ ● ■
JVZ 14S 361K	360	±10%	230	300	595	50	6000	3	0.6	130	☆ ● ■
JVZ 14S 391K	390	±10%	250	320	650	50	6000	3	0.6	140	☆ ● ■
JVZ 14S 431K	430	±10%	275	350	710	50	6000	3	0.6	155	☆ ● ■
JVZ 14S 471K	470	±10%	300	385	775	50	6000	3	0.6	175	☆ ● ■
JVZ 14S 511K	510	±10%	320	418	842	50	6000	3	0.6	190	☆ ● ■
JVZ 14S 561K	560	±10%	350	460	920	50	6000	3	0.6	205	☆ ● ■
JVZ 14S 621K	620	±10%	385	505	1025	50	6000	3	0.6	215	☆ ● ■
JVZ 14S 681K	680	±10%	420	560	1120	50	6000	3	0.6	225	☆ ● ■
JVZ 14S 751K	750	±10%	460	615	1240	50	6000	3	0.6	230	☆ ● ■
JVZ 14S 781K	780	±10%	485	640	1290	50	6000	3	0.6	233	☆ ● ■
JVZ 14S 821K	820	±10%	510	670	1355	50	6000	3	0.6	235	☆ ● ■
JVZ 14S 911K	910	±10%	550	745	1500	50	6000	3	0.6	255	☆ ● ■
JVZ 14S 102K	1000	±10%	625	825	1650	50	6000	3	0.6	283	☆ ● ■
JVZ 14S 112K	1100	±10%	680	895	1815	50	6000	3	0.6	310	☆ ● ■

## Metal Oxide Varistor JVZ Series

Ø 20mm

### Rating and Characteristics

Part No.	Varistor Voltage at 1mA		Maximum Allowable Voltage		Maximum Clamping Voltage		Withstanding Surge Current (8/20us)	Nominal Discharge Current (8/20us)	Rated Wattage	Energy (10/1000us)	Certification
	DC (V)	Tolerance	AC rms (V)	DC (V)	V@ ic (V)	ic (A)	1 Time (A)	In (KA)	(W)	(J)	
JVZ 20S 220M	22	±20%	14	18	43	20	3000	2	0.2	16	☆ ○ □
JVZ 20S 270M	27	±20%	17	22	53	20	3000	2	0.2	19	☆ ○ □
JVZ 20S 330M	33	±20%	20	26	65	20	3000	2	0.2	24	☆ ○ □
JVZ 20S 390L	39	±15%	25	31	77	20	3000	2	0.2	28	☆ ○ □
JVZ 20S 470L	47	±15%	30	38	93	20	3000	2	0.2	34	☆ ○ □
JVZ 20S 560L	56	±15%	35	45	110	20	3000	2	0.2	41	☆ ○ □
JVZ 20S 680L	68	±15%	40	56	135	20	3000	2	0.2	49	☆ ○ □
JVZ 20S 820L	82	±15%	50	65	135	100	10000	5	1	56	☆ ○ □
JVZ 20S 101K	100	±10%	60	85	165	100	10000	5	1	72	☆ ○ □
JVZ 20S 121K	120	±10%	75	100	200	100	10000	5	1	88	☆ ○ □
JVZ 20S 151K	150	±10%	95	125	250	100	10000	5	1	106	☆ ○ □
JVZ 20S 181K	180	±10%	115	150	300	100	10000	5	1	130	☆ ● □
JVZ 20S 201K	200	±10%	130	170	340	100	10000	5	1	140	☆ ● ■
JVZ 20S 221K	220	±10%	140	180	360	100	10000	5	1	155	☆ ● ■
JVZ 20S 241K	240	±10%	150	200	395	100	10000	5	1	168	☆ ● ■
JVZ 20S 271K	270	±10%	175	225	455	100	10000	5	1	190	☆ ● ■
JVZ 20S 301K	300	±10%	195	250	505	100	10000	5	1	210	☆ ● ■
JVZ 20S 331K	330	±10%	210	275	550	100	10000	5	1	228	☆ ● ■
JVZ 20S 361K	360	±10%	230	300	595	100	10000	5	1	255	☆ ● ■
JVZ 20S 391K	390	±10%	250	320	650	100	10000	5	1	275	☆ ● ■
JVZ 20S 431K	430	±10%	275	350	710	100	10000	5	1	303	☆ ● ■
JVZ 20S 471K	470	±10%	300	385	775	100	10000	5	1	350	☆ ● ■
JVZ 20S 511K	510	±10%	320	418	842	100	10000	5	1	382	☆ ● ■
JVZ 20S 561K	560	±10%	350	460	920	100	10000	5	1	410	☆ ● ■
JVZ 20S 621K	620	±10%	385	505	1025	100	10000	5	1	420	☆ ● ■
JVZ 20S 681K	680	±10%	420	560	1120	100	10000	5	1	430	☆ ● ■
JVZ 20S 751K	750	±10%	460	615	1240	100	10000	5	1	440	☆ ● ■
JVZ 20S 781K	780	±10%	485	640	1290	100	10000	5	1	450	☆ ● ■
JVZ 20S 821K	820	±10%	510	670	1355	100	10000	5	1	460	☆ ● ■
JVZ 20S 911K	910	±10%	550	745	1500	100	10000	5	1	510	☆ ● ■
JVZ 20S 102K	1000	±10%	625	825	1650	100	10000	5	1	566	☆ ● ■
JVZ 20S 112K	1100	±10%	680	895	1815	100	10000	5	1	620	☆ ● ■

## Metal Oxide Varistor JVZ Series

### Ultra Surge Series Specification

#### Agency Approvals

Agency	UL	CUL	VDE		CQC	
Agency Approvals	UL1449 4 <sup>th</sup> Edition	CSA 22.2 No. 269.5-17	IEC61051-1 IEC61051-2 IEC61051-2-2	IEC61051-1 IEC61051-2 IEC61051-2-2 IEC62368-1:2018/G.8.1	GB/T10193-1997 GB/T10194-1997	GB4943.1-2011 GB/T10193-1997 GB/T10194-1997 GB8898-2011
Title	Transient Voltage Surge Suppressors	Transient Voltage Surge Suppressors	Varistors for use in electronic equipment		Engaged in Voluntary Product Certification	
File No.	VZCA2.E325508	VZCA8.E325508	40046994		CQC19001230701/703/704/705/706	
Symbols	☆		○	●	□	■

#### Ø 5mm

#### Rating and Characteristics

Part No.	Varistor Voltage at 0.1mA		Maximum Allowable Voltage		Maximum Clamping Voltage		Withstanding Surge Current (8/20us)	Nominal Discharge Current (8/20us)	Rated Wattage	Energy (10/1000us)	Certification
	DC (V)	Tolerance	AC rms (V)	DC (V)	V@ic (V)	Ic (A)	1 Time (A)	In (KA)	(W)	(J)	
JVZ 05U 180M	18	±20%	11	14	40	1	750	0.25	0.01	0.6	☆ □
JVZ 05U 220L	22	±15%	14	18	48	1	750	0.25	0.01	0.7	☆ □
JVZ 05U 270K	27	±10%	17	22	60	1	750	0.25	0.01	0.9	☆ □
JVZ 05U 330K	33	±10%	20	26	73	1	750	0.25	0.01	1.1	☆ □
JVZ 05U 390K	39	±10%	25	31	86	1	750	0.25	0.01	1.2	☆ □
JVZ 05U 470K	47	±10%	30	38	104	1	750	0.25	0.01	1.5	☆ □
JVZ 05U 560K	56	±10%	35	45	123	1	750	0.25	0.01	1.8	☆ □
JVZ 05U 680K	68	±10%	40	56	150	1	750	0.25	0.01	2.1	☆ □

## Metal Oxide Varistor JVZ Series

Ø 7mm

### Rating and Characteristics

Part No.	Varistor Voltage at 1mA		Maximum Allowable Voltage		Maximum Clamping Voltage		Withstanding Surge Current (8/20us)	Nominal Discharge Current (8/20us)	Rated Wattage	Energy (10/1000us)	Certification
	DC (V)	Tolerance	AC rms (V)	DC (V)	V@ ic (V)	ic (A)	1 Time (A)	In (KA)	(W)	(J)	
JVZ 07U 180M	18	±20%	11	14	36	2.5	1500	0.5	0.02	1.2	☆ ○ □
JVZ 07U 220L	22	±15%	14	18	43	2.5	1500	0.5	0.02	1.4	☆ ○ □
JVZ 07U 270K	27	±10%	17	22	53	2.5	1500	0.5	0.02	1.7	☆ ○ □
JVZ 07U 330K	33	±10%	20	26	65	2.5	1500	0.5	0.02	2.2	☆ ○ □
JVZ 07U 390K	39	±10%	25	31	77	2.5	1500	0.5	0.02	2.4	☆ ○ □
JVZ 07U 470K	47	±10%	30	38	93	2.5	1500	0.5	0.02	3.0	☆ ○ □
JVZ 07U 560K	56	±10%	35	45	110	2.5	1500	0.5	0.02	3.5	☆ ○ □
JVZ 07U 680K	68	±10%	40	56	135	2.5	1500	0.5	0.02	4.3	☆ ○ □
JVZ 07U 181K	180	±10%	115	150	300	10	1800	1	0.25	19	☆ ○ □
JVZ 07U 201K	200	±10%	130	170	340	10	1800	1	0.25	21	☆ ○ □
JVZ 07U 221K	220	±10%	140	180	360	10	1800	1	0.25	23	☆ ○ □
JVZ 07U 241K	240	±10%	150	200	395	10	1800	1	0.25	25	☆ ○ □
JVZ 07U 271K	270	±10%	175	225	455	10	1800	1	0.25	28	☆ ○ □
JVZ 07U 301K	300	±10%	195	250	505	10	1800	1	0.25	32	☆ ○ □
JVZ 07U 331K	330	±10%	210	275	550	10	1800	1	0.25	34	☆ ○ □
JVZ 07U 361K	360	±10%	230	300	595	10	1800	1	0.25	37	☆ ○ □
JVZ 07U 391K	390	±10%	250	320	650	10	1800	1	0.25	40	☆ ○ □
JVZ 07U 431K	430	±10%	275	350	710	10	1800	1	0.25	46	☆ ○ □
JVZ 07U 471K	470	±10%	300	385	775	10	1800	1	0.25	49	☆ ○ □
JVZ 07U 511K	510	±10%	320	418	842	10	1800	1	0.25	54	☆ ○ □
JVZ 07U 561K	560	±10%	350	460	920	10	1800	1	0.25	55	☆ ○ □
JVZ 07U 621K	620	±10%	385	505	1025	10	1800	1	0.25	59	☆ ○ □
JVZ 07U 681K	680	±10%	420	560	1120	10	1800	1	0.25	62	☆ ○ □
JVZ 07U 751K	750	±10%	460	615	1240	10	1800	1	0.25	66	☆ ○ □
JVZ 07U 781K	780	±10%	485	640	1290	10	1800	1	0.25	68	☆ ○ □
JVZ 07U 821K	820	±10%	510	670	1355	10	1800	1	0.25	71	☆ ○ □

## Metal Oxide Varistor JVZ Series

Ø 10mm

### Rating and Characteristics

Part No.	Varistor Voltage at 1mA		Maximum Allowable Voltage		Maximum Clamping Voltage		Withstanding Surge Current (8/20us)	Nominal Discharge Current (8/20us)	Rated Wattage	Energy (10/100us)	Certification
	DC (V)	Tolerance	AC rms (V)	DC (V)	V@ ic (V)	ic (A)	1 Time (A)	In (KA)	(W)	(J)	
JVZ 10U 180M	18	±20%	11	14	36	5	3000	1	0.05	2.4	☆ ○ □
JVZ 10U 220L	22	±15%	14	18	43	5	3000	1	0.05	2.7	☆ ○ □
JVZ 10U 270K	27	±10%	17	22	53	5	3000	1	0.05	3.5	☆ ○ □
JVZ 10U 330K	33	±10%	20	26	65	5	3000	1	0.05	4.4	☆ ○ □
JVZ 10U 390K	39	±10%	25	31	77	5	3000	1	0.05	4.7	☆ ○ □
JVZ 10U 470K	47	±10%	30	38	93	5	3000	1	0.05	6	☆ ○ □
JVZ 10U 560K	56	±10%	35	45	110	5	3000	1	0.05	7	☆ ○ □
JVZ 10U 680K	68	±10%	40	56	135	5	3000	1	0.05	8.5	☆ ○ □
JVZ 10U 181K	180	±10%	115	150	300	25	4500	3	0.4	47	☆ ● □
JVZ 10U 201K	200	±10%	130	170	340	25	4500	3	0.4	52	☆ ● ■
JVZ 10U 221K	220	±10%	140	180	360	25	4500	3	0.4	58	☆ ● ■
JVZ 10U 241K	240	±10%	150	200	395	25	4500	3	0.4	64	☆ ● ■
JVZ 10U 271K	270	±10%	175	225	455	25	4500	3	0.4	67	☆ ● ■
JVZ 10U 301K	300	±10%	195	250	505	25	4500	3	0.4	70	☆ ● ■
JVZ 10U 331K	330	±10%	210	275	550	25	4500	3	0.4	72	☆ ● ■
JVZ 10U 361K	360	±10%	230	300	595	25	4500	3	0.4	76	☆ ● ■
JVZ 10U 391K	390	±10%	250	320	650	25	4500	3	0.4	82	☆ ● ■
JVZ 10U 431K	430	±10%	275	350	710	25	4500	3	0.4	93	☆ ● ■
JVZ 10U 471K	470	±10%	300	385	775	25	4500	3	0.4	99	☆ ● ■
JVZ 10U 511K	510	±10%	320	418	842	25	4500	3	0.4	107	☆ ● ■
JVZ 10U 561K	560	±10%	350	460	920	25	4500	3	0.4	113	☆ ● ■
JVZ 10U 621K	620	±10%	385	505	1025	25	4500	3	0.4	125	☆ ● ■
JVZ 10U 681K	680	±10%	420	560	1120	25	4500	3	0.4	128	☆ ● ■
JVZ 10U 751K	750	±10%	460	615	1240	25	4500	3	0.4	134	☆ ● ■
JVZ 10U 781K	780	±10%	485	640	1290	25	4500	3	0.4	139	☆ ● ■
JVZ 10U 821K	820	±10%	510	670	1355	25	4500	3	0.4	146	☆ ● ■
JVZ 10U 911K	910	±10%	550	745	1500	25	4500	3	0.4	152	☆ ● ■
JVZ 10U 102K	1000	±10%	625	825	1650	25	4500	3	0.4	170	☆ ● ■
JVZ 10U 112K	1100	±10%	680	895	1815	25	4500	3	0.4	180	☆ ● ■



## Metal Oxide Varistor JVZ Series

Ø 14mm

### Rating and Characteristics

Part No.	Varistor Voltage at 1mA		Maximum Allowable Voltage		Maximum Clamping Voltage		Withstanding Surge Current (8/20us)	Nominal Discharge Current (8/20us)	Rated Wattage	Energy (10/1000us)	Certification
	DC (V)	Tolerance	AC rms (V)	DC (V)	V@ ic (V)	ic (A)	1Time (A)	In (KA)	(W)	(J)	
JVZ 14U 180M	18	±20%	11	14	36	10	5000	2	0.1	4.7	☆ ○ □
JVZ 14U 220L	22	±15%	14	18	43	10	5000	2	0.1	5.4	☆ ○ □
JVZ 14U 270K	27	±10%	17	22	53	10	5000	2	0.1	6.9	☆ ○ □
JVZ 14U 330K	33	±10%	20	26	65	10	5000	2	0.1	8.8	☆ ○ □
JVZ 14U 390K	39	±10%	25	31	77	10	5000	2	0.1	9.4	☆ ○ □
JVZ 14U 470K	47	±10%	30	38	93	10	5000	2	0.1	12	☆ ○ □
JVZ 14U 560K	56	±10%	35	45	110	10	5000	2	0.1	14	☆ ○ □
JVZ 14U 680K	68	±10%	40	56	135	10	5000	2	0.1	17	☆ ○ □
JVZ 14U 181K	180	±10%	115	150	300	50	8000	3	0.6	60	☆ ● □
JVZ 14U 201K	200	±10%	130	170	340	50	8000	3	0.6	82	☆ ● ■
JVZ 14U 221K	220	±10%	140	180	360	50	8000	3	0.6	90	☆ ● ■
JVZ 14U 241K	240	±10%	150	200	395	50	8000	3	0.6	98	☆ ● ■
JVZ 14U 271K	270	±10%	175	225	455	50	8000	3	0.6	116	☆ ● ■
JVZ 14U 301K	300	±10%	195	250	505	50	8000	3	0.6	128	☆ ● ■
JVZ 14U 331K	330	±10%	210	275	550	50	8000	3	0.6	140	☆ ● ■
JVZ 14U 361K	360	±10%	230	300	595	50	8000	3	0.6	158	☆ ● ■
JVZ 14U 391K	390	±10%	250	320	650	50	8000	3	0.6	170	☆ ● ■
JVZ 14U 431K	430	±10%	275	350	710	50	8000	3	0.6	185	☆ ● ■
JVZ 14U 471K	470	±10%	300	385	775	50	8000	3	0.6	205	☆ ● ■
JVZ 14U 511K	510	±10%	320	418	842	50	8000	3	0.6	220	☆ ● ■
JVZ 14U 561K	560	±10%	350	460	920	50	8000	3	0.6	240	☆ ● ■
JVZ 14U 621K	620	±10%	385	505	1025	50	8000	3	0.6	250	☆ ● ■
JVZ 14U 681K	680	±10%	420	560	1120	50	8000	3	0.6	260	☆ ● ■
JVZ 14U 751K	750	±10%	460	615	1240	50	8000	3	0.6	270	☆ ● ■
JVZ 14U 781K	780	±10%	485	640	1290	50	8000	3	0.6	274	☆ ● ■
JVZ 14U 821K	820	±10%	510	670	1355	50	8000	3	0.6	280	☆ ● ■
JVZ 14U 911K	910	±10%	550	745	1500	50	8000	3	0.6	295	☆ ● ■
JVZ 14U 102K	1000	±10%	625	825	1650	50	8000	3	0.6	335	☆ ● ■
JVZ 14U 112K	1100	±10%	680	895	1815	50	8000	3	0.6	360	☆ ● ■

## Metal Oxide Varistor JVZ Series

Ø 20mm

### Rating and Characteristics

Part No.	Varistor Voltage at 1mA		Maximum Allowable Voltage		Maximum Clamping Voltage		Withstanding Surge Current (8/20us)	Nominal Discharge Current (8/20us)	Rated Wattage	Energy (10/1000us)	Certification
	DC (V)	Tolerance	AC rms (V)	DC (V)	V@ ic (V)	ic (A)	1 Time (A)	In (KA)	(W)	(J)	
JVZ 20U 180M	18	±20%	11	14	36	20	9000	3	0.2	7	☆ ○ □
JVZ 20U 220L	22	±15%	14	18	43	20	9000	3	0.2	8	☆ ○ □
JVZ 20U 270K	27	±10%	17	22	53	20	9000	3	0.2	10	☆ ○ □
JVZ 20U 330K	33	±10%	20	26	65	20	9000	3	0.2	12	☆ ○ □
JVZ 20U 390K	39	±10%	25	31	77	20	9000	3	0.2	14	☆ ○ □
JVZ 20U 470K	47	±10%	30	38	93	20	9000	3	0.2	17	☆ ○ □
JVZ 20U 560K	56	±10%	35	45	110	20	9000	3	0.2	20	☆ ○ □
JVZ 20U 680K	68	±10%	40	56	135	20	9000	3	0.2	24	☆ ○ □
JVZ 20U 181K	180	±10%	115	150	300	100	13000	5	1	152	☆ ● □
JVZ 20U 201K	200	±10%	130	170	340	100	13000	5	1	175	☆ ● ■
JVZ 20U 221K	220	±10%	140	180	360	100	13000	5	1	185	☆ ● ■
JVZ 20U 241K	240	±10%	150	200	395	100	13000	5	1	198	☆ ● ■
JVZ 20U 271K	270	±10%	175	225	455	100	13000	5	1	220	☆ ● ■
JVZ 20U 301K	300	±10%	195	250	505	100	13000	5	1	245	☆ ● ■
JVZ 20U 331K	330	±10%	210	275	550	100	13000	5	1	268	☆ ● ■
JVZ 20U 361K	360	±10%	230	300	595	100	13000	5	1	315	☆ ● ■
JVZ 20U 391K	390	±10%	250	320	650	100	13000	5	1	350	☆ ● ■
JVZ 20U 431K	430	±10%	275	350	710	100	13000	5	1	380	☆ ● ■
JVZ 20U 471K	470	±10%	300	385	775	100	13000	5	1	405	☆ ● ■
JVZ 20U 511K	510	±10%	320	418	842	100	13000	5	1	445	☆ ● ■
JVZ 20U 561K	560	±10%	350	460	920	100	13000	5	1	475	☆ ● ■
JVZ 20U 621K	620	±10%	385	505	1025	100	13000	5	1	490	☆ ● ■
JVZ 20U 681K	680	±10%	420	560	1120	100	13000	5	1	500	☆ ● ■
JVZ 20U 751K	750	±10%	460	615	1240	100	13000	5	1	525	☆ ● ■
JVZ 20U 781K	780	±10%	485	640	1290	100	13000	5	1	530	☆ ● ■
JVZ 20U 821K	820	±10%	510	670	1355	100	13000	5	1	545	☆ ● ■
JVZ 20U 911K	910	±10%	550	745	1500	100	13000	5	1	595	☆ ● ■
JVZ 20U 102K	1000	±10%	625	825	1650	100	13000	5	1	650	☆ ● ■
JVZ 20U 112K	1100	±10%	680	895	1815	100	13000	5	1	720	☆ ● ■

# Metal Oxide Varistor JVZ Series

## Dimensions

Dimension Table

unit : mm

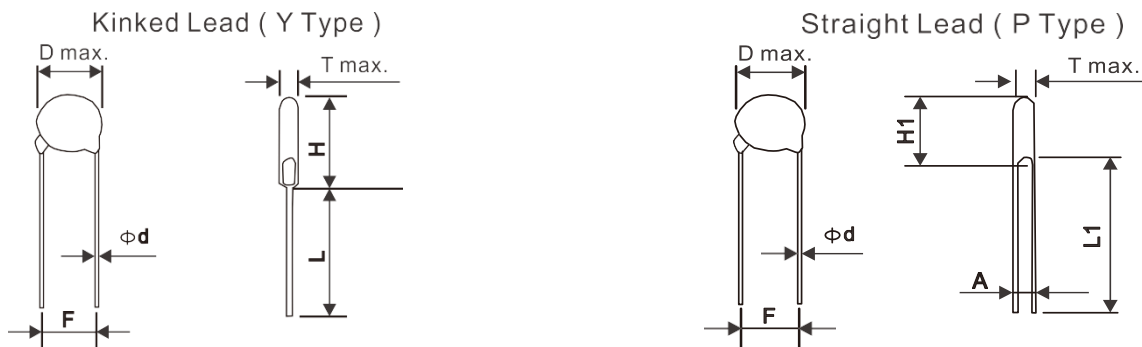

Diameter	5mm	7mm	10mm	14mm	20mm	25mm
D max.	7.5	9.0	12.5	16.5	23	29
$d \pm 0.05$	0.6	0.6	0.8	0.8	1.0	1.0
$F \pm 1.0$	5.0	5.0	7.5	7.5	10.0	10.0
H max.	11.0	12.5	17/*19	22/*23	28/*29	36
L1 min.	25.0	25.0	25.0	25.0	25.0	25.0
L min.	24.0	24.0	24.0	24.0	24.0	20.0

\*Just for 182K

Table of Tmax., A & H1 max.

Diameter	5mm			7mm			10mm			14mm			20mm			25mm		
	T max.	A $\pm 0.8$	H1 max.	T max.	A $\pm 0.8$	H1 max.	T max.	A $\pm 0.8$	H1 max.	T max.	A $\pm 0.8$	H1 max.	T max.	A $\pm 0.8$	H1 max.	T max.	A $\pm 0.8$	H1 max.
180M	3.9	0.8	10.5	3.9	0.8	12.0	4.3	0.8	15.0	4.3	0.9	19.5	/	/	/	/	/	/
220M/L	4.1	0.9	10.5	4.1	0.9	12.0	4.5	0.9	15.0	4.5	1.0	19.5	4.9	1.0	26.5	/	/	/
270M/K	4.3	0.9	10.5	4.3	0.9	12.0	4.7	0.9	15.0	4.7	1.0	19.5	5.1	1.1	26.5	/	/	/
330M/K	4.5	1.0	10.5	4.5	1.0	12.0	4.9	1.0	15.0	4.9	1.2	19.5	5.3	1.2	26.5	/	/	/
390L/K	4.5	1.2	10.5	4.5	1.2	12.0	5.1	1.2	15.0	5.1	1.4	19.5	5.4	1.4	26.5	/	/	/
470L/K	4.8	1.2	10.5	4.8	1.2	12.0	5.3	1.2	15.0	5.4	1.4	19.5	5.6	1.4	26.5	/	/	/
560L/K	4.8	1.4	10.5	4.8	1.4	12.0	5.5	1.4	15.0	5.6	1.6	19.5	5.6	1.6	26.5	/	/	/
680L/K	5.1	1.7	10.5	5.1	1.7	12.0	5.7	1.6	15.0	5.6	1.9	19.5	5.9	1.9	26.5	/	/	/
820K	3.8	0.8	10.5	3.8	0.8	12.0	4.3	0.8	15.0	4.3	1.0	19.5	4.7	1.1	26.5	/	/	/
101K	3.9	0.8	10.5	3.9	0.8	12.0	4.4	0.8	15.0	4.5	1.0	19.5	4.9	1.2	26.5	/	/	/
121K	4.1	0.9	10.5	4.1	0.9	12.0	4.5	0.9	15.0	4.6	1.1	19.5	5.1	1.3	26.5	/	/	/
151K	4.5	1.2	10.5	4.5	1.2	12.0	4.9	1.2	15.0	5.0	1.4	19.5	5.4	1.6	26.5	/	/	/
181K	3.9	1.0	10.5	3.9	1.0	12.0	4.3	1.0	15.0	4.3	1.2	19.5	5.0	1.4	26.5	/	/	/
201K	4.0	1.0	10.5	4.0	1.0	12.0	4.4	1.0	15.0	4.4	1.2	19.5	5.1	1.4	26.5	5.4	2.5	35
221K	4.0	1.1	10.5	4.0	1.1	12.0	4.4	1.1	15.0	4.4	1.3	19.5	5.2	1.5	26.5	5.6	2.6	35
241K	4.2	1.1	10.5	4.2	1.3	12.0	4.6	1.3	15.0	4.6	1.5	19.5	5.3	1.7	26.5	5.7	2.8	35
271K	4.4	1.3	10.5	4.4	1.4	12.0	4.8	1.4	15.0	4.8	1.5	19.5	5.5	1.9	26.5	6.0	3.0	35
301K	4.4	1.3	10.5	4.4	1.5	12.0	4.8	1.6	15.0	4.8	1.7	19.5	5.7	2.1	26.5	6.3	3.2	35
331K	4.5	1.3	10.5	4.5	1.5	12.0	4.9	1.6	15.0	4.9	1.7	19.5	5.8	2.1	26.5	6.6	3.4	35
361K	4.7	1.8	10.5	4.6	1.9	12.0	5.0	1.9	15.0	5.0	2.1	19.5	6.0	2.3	26.5	6.8	3.6	35
391K	4.8	2.0	11.0	4.8	2.0	12.5	5.2	2.2	15.0	5.2	2.2	19.5	6.2	2.4	26.5	7.1	3.9	35
431K	5.1	2.1	11.0	5.1	2.0	12.5	5.5	2.5	15.0	5.5	2.5	19.5	6.6	2.7	26.5	7.2	3.3	35
471K	5.2	2.2	11.0	5.2	2.3	12.5	5.6	2.6	15.0	5.6	2.7	19.5	6.8	2.9	27.0	7.4	3.5	35
511K	5.6	2.5	11.5	5.6	2.5	12.5	5.8	3.1	15.0	5.8	3.1	20.0	7.0	3.3	27.0	7.6	3.8	35
561K	5.7	2.8	11.5	5.7	2.8	12.5	6.1	3.4	15.0	6.1	3.4	20.0	7.3	3.6	27.0	7.9	4.0	35
621K	6.0	3.1	11.5	6.0	3.1	12.5	6.4	4.0	15.0	6.4	3.8	20.0	7.6	4.1	27.0	8.2	4.4	35
681K	6.3	3.4	11.5	6.3	3.4	12.5	6.8	4.4	15.0	6.8	4.1	20.0	8.0	4.4	27.0	8.3	4.7	35
751K	6.7	3.7	11.5	6.8	3.7	12.5	7.2	4.4	15.0	7.2	4.3	20.0	8.4	4.5	27.0	8.7	5.0	35
781K	/	/	/	7.0	3.9	12.5	7.3	4.6	15.0	7.3	4.6	20.0	8.6	4.8	27.0	8.9	5.2	35
821K	/	/	/	7.2	4.1	12.5	7.6	4.6	15.0	7.6	4.6	20.0	8.8	4.8	27.0	9.1	5.4	35
911K	/	/	/	/	/	/	8.2	5.4	16.0	8.2	5.4	20.5	9.3	5.7	27.0	9.6	5.9	35
102K	/	/	/	/	/	/	8.5	5.4	16.0	8.6	5.6	20.5	9.9	5.8	27.0	/	/	/
112K	/	/	/	/	/	/	9.1	5.7	16.0	9.1	6.1	20.5	10.3	6.3	27.0	/	/	/
122K	/	/	/	/	/	/	9.9	6.3	17.0	10.0	6.7	21.0	11.3	6.9	27.5	/	/	/
142K	/	/	/	/	/	/	10.7	7.4	17.5	10.9	7.8	21.5	12.8	8.0	28.0	/	/	/
162K	/	/	/	/	/	/	11.5	8.6	17.5	11.8	9.0	21.5	13.0	9.2	28.5	/	/	/
182K	/	/	/	/	/	/	12.6	9.8	17.5	12.8	10.2	21.5	13.5	10.4	29.0	/	/	/

## Metal Oxide Varistor JVZ Series

### Tape and Reel Dimensions

1/2" pitch

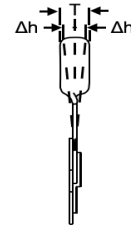
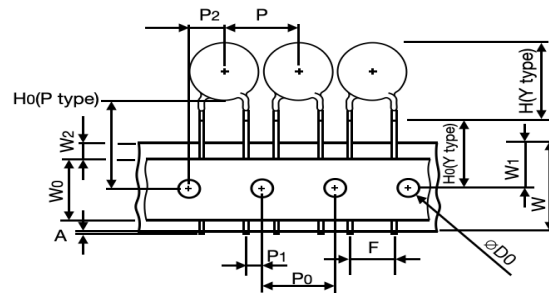

1.0" pitch

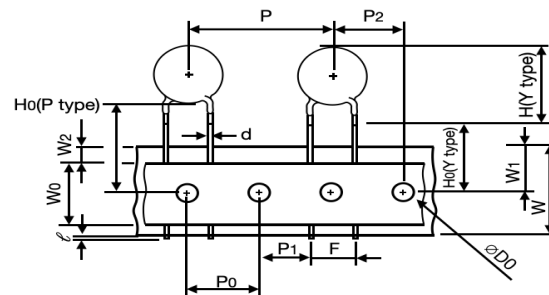

Symbols	Item	5 / 7 mm	10 / 14 mm	20mm
A	Cut out length	1.1 mm max.	1.1 mm max.	
H (Y type)	Height of Top	See H max. table		
H0(Y type)	Height to seating plane	16.0 ± 0.5 mm (*± 1.0 mm)	16.0 ± 0.5 mm (*± 1.0 mm)	
H0(P type)	Height of component from hole center	16.0 ~ 21.0 mm	16.0 ~ 21.0 mm	
Δh	Front to back deviation	0 ± 2.0 mm	0 ± 2.0 mm	
W	Carrier tape width	18 <sup>+1.0</sup> <sub>-0.5</sub> mm	18 <sup>+1.0</sup> <sub>-0.5</sub> mm	
W0	Hold down tape width	10.0 mm	12.0 mm	
W1	Sprocket hole position	9.0 <sup>+0.75</sup> <sub>-0.5</sub> mm	9.0 <sup>+0.75</sup> <sub>-0.5</sub> mm	
W2	Adhesive tape position	3.0 mm max.	3.0 mm max.	
F	Component lead spacing	5.0 ± 1.0 mm	7.5 ± 1.0 mm	10.0 ± 1.0 mm
P	Pitch of component	12.7 ± 1.0 mm	25.4 ± 1.0 mm	
P0	Sprocket hole pitch	12.7 ± 0.3 mm	12.7 ± 0.3 mm	
P1	Lead length from hole center to lead	3.85 ± 0.7 mm	8.95 ± 0.7 mm	7.7 ± 0.7 mm
P2	Length from hole center to disk center	6.35 ± 1.3 mm	12.7 ± 1.3 mm	
D0	Sprocket hole diameter	4.0 ± 0.2 mm	4.0 ± 0.2 mm	
d	Lead wire diameter	0.6 ± 0.05 mm	0.8 ± 0.05 mm	1.0 ± 0.05 mm
T	Disk thickness	See T max. table	See T max. table	
t1	Total thickness tape	0.7 ± 0.05 mm	0.7 ± 0.05 mm	
t2	Total thickness	1.6 mm max.	1.8 mm max.	

## Metal Oxide Varistor JVZ Series

### Marking and Packaging

#### MARKING

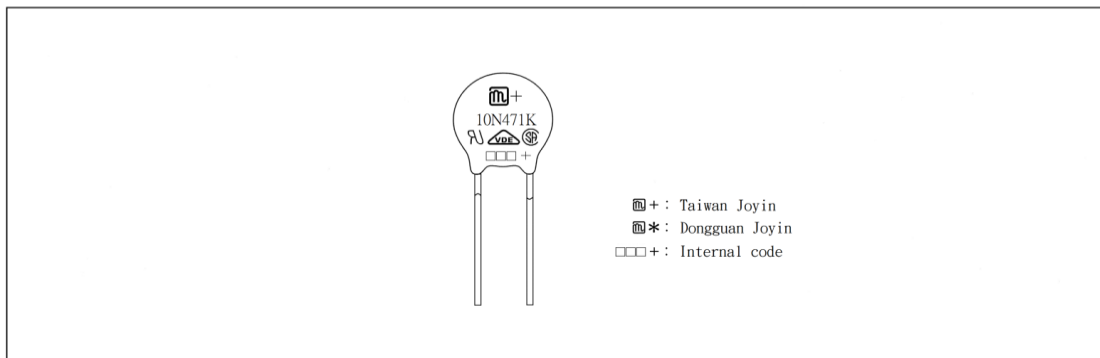

#### PACKAGING

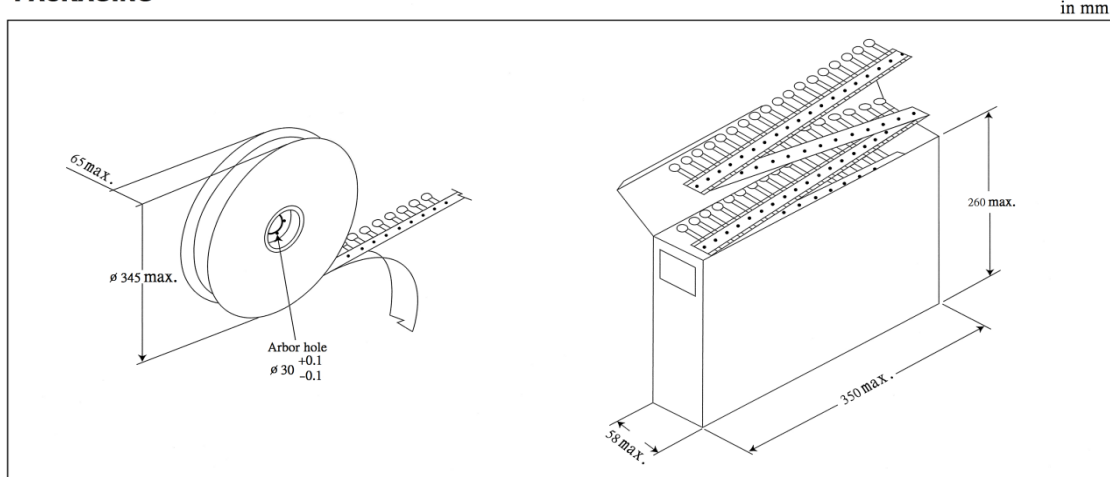

Series Part No.	5mm			7mm			10mm			14mm			20mm			25mm
	Bulk (Box)	Reel	Ammo	Bulk (Box)	Reel	Ammo	Bulk (Box)	Reel	Ammo	Bulk (Box)	Reel	Ammo	Bulk (Box)	Reel	Ammo	Bulk (Box)
180M ~ 470K	5000	1500	1500	5000	1500	1500	2500	1000	500	1500	750	500	750	500	500	-
560K ~ 680K	5000	1500	1000	5000	1500	1000	2500	1000	500	1500	750	500	750	500	500	-
820K ~ 391K	5000	1500	1500	5000	1500	1500	2500	1000	500	1500	750	500	750	500	500	750
431K ~ 471K	5000	1500	1000	5000	1000	1000	2000	750	500	1500	750	500	750	500	500	750
511K ~ 821K	4000	1000	1000	4000	1000	1000	1500	500	500	750	500	500	450	500	500	450
911K ~ 122K	-	-	-	-	-	-	1500	500	350	750	500	350	450	-	-	450
142K ~ 182K	-	-	-	-	-	-	750	-	-	450	-	-	300	-	-	-

Packaging	Bulk (Box)	Reel	Reel (14 mm, 20 mm)	Ammo (5 mm, 7 mm)	Ammo (10 mm, 14 mm)	Ammo (20 mm)
Box size ( mm )	290 × 155 × 110	350 × 350 × 105	346 × 346 × 72	335 × 245 × 43	347 × 246 × 50	348 × 255 × 60
Carton size ( mm )	328 × 310 × 250	370 × 370 × 590	370 × 370 × 468	515 × 354 × 258	515 × 364 × 246	535 × 365 × 275
One carton with	4 Boxes	5 Boxes ( 10 reels )	6 Boxes ( 6 reels )	10 Boxes	8 Boxes	8 Boxes